



High forward current capability  
Low forward losses  
Low thermal resistance  
High load cycle capability

**Rectifier Diode  
For Welding  
Type D056-9500-4**

Average forward current	$I_{FAV}$	11814 A
Repetitive peak reverse voltage	$V_{RRM}$	200 ÷ 400 V
$V_{RRM}$ , V	200	400
Voltage code	2	4
$T_j$ , °C	- 60 ÷ 180	

**MAXIMUM ALLOWABLE RATINGS**

Symbols and parameters		Units	Values	Test conditions
<b>ON-STATE</b>				
$I_{FAV}$	Average forward current	A	9500 9657 11814	$T_c = 112$ °C; Double side cooled; $T_c = 110$ °C; Double side cooled; $T_c = 85$ °C; Double side cooled; 180° half-sine wave; 50 Hz
$I_{FRMS}$	RMS forward current	A	14915	$T_c = 112$ °C; Double side cooled; 180° half-sine wave; 50 Hz
$I_{FSM}$	Surge forward current	kA	70.0 81.0	$T_j = T_{j\max}$ $T_j = 25$ °C 180° half-sine wave; 50 Hz ( $t_p = 10$ ms); single pulse; $V_R = 0$ V
			74.0 85.0	$T_j = T_{j\max}$ $T_j = 25$ °C 180° half-sine wave; 60 Hz ( $t_p = 8.3$ ms); single pulse; $V_R = 0$ V
$I^2t$	Safety factor	$A^2s \cdot 10^3$	24500 32805	$T_j = T_{j\max}$ $T_j = 25$ °C 180° half-sine wave; 50 Hz ( $t_p = 10$ ms); single pulse; $V_R = 0$ V
			22725 29980	$T_j = T_{j\max}$ $T_j = 25$ °C 180° half-sine wave; 60 Hz ( $t_p = 8.3$ ms); single pulse; $V_R = 0$ V
<b>BLOCKING</b>				
$V_{RRM}$	Repetitive peak reverse voltages	V	200 ÷ 400	$T_{j\min} < T_j < T_{j\max}$ ; 180° half-sine wave; 50 Hz;
$V_{RSM}$	Non-repetitive peak reverse voltages	V	250 ÷ 450	$T_{j\min} < T_j < T_{j\max}$ ; 180° half-sine wave; 50 Hz; single pulse;
$V_R$	Reverse continuous voltages	V	$0.75 \cdot V_{RRM}$	$T_j = T_{j\max}$ ;
<b>THERMAL</b>				
$T_{stg}$	Storage temperature	°C	- 50 ÷ 40	
$T_j$	Operating junction temperature	°C	- 60 ÷ 180	
<b>MECHANICAL</b>				
F	Mounting force	kN	45.0 ÷ 50.0	
a	Acceleration	$m/s^2$	50	Device unclamped
			100	Device clamped

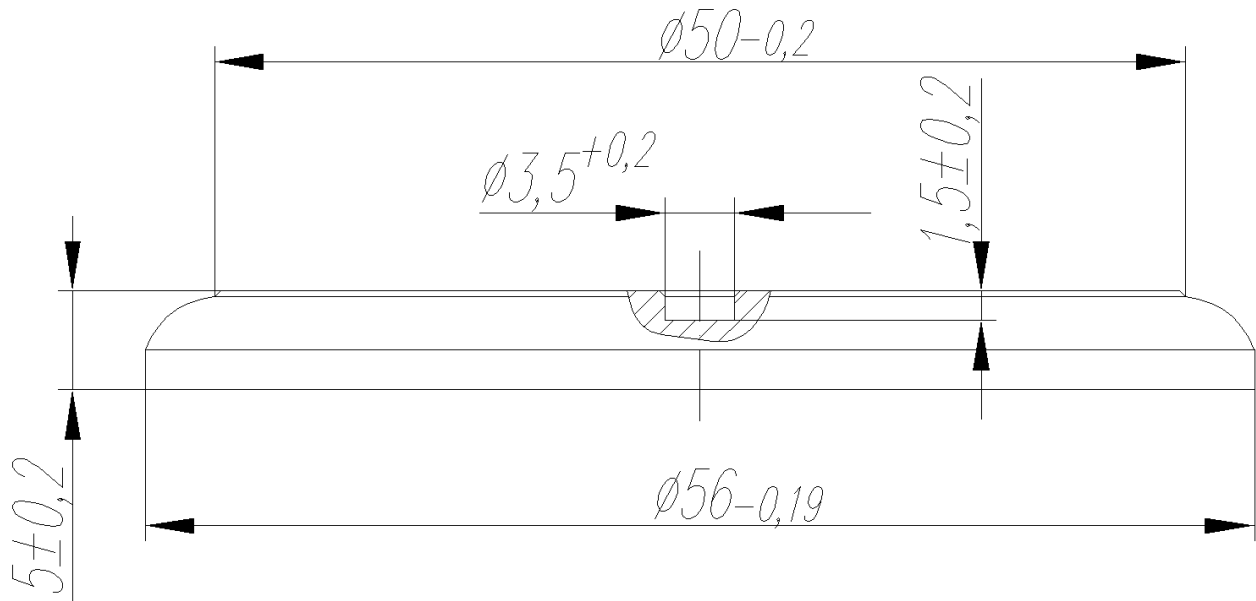
## CHARACTERISTICS

Symbols and parameters		Units	Values	Conditions
<b>ON-STATE</b>				
$V_{FM}$	Peak forward voltage, max	V	1.08 0.98	$T_j=25\text{ }^\circ\text{C}; I_{FM} = 6300\text{ A}$ $T_j=T_{j\text{ max}}; I_{FM} = 8000\text{ A}$
$V_{F(TO)}$	Forward threshold voltage, max	V	0.74	$T_j=T_{j\text{ max}};$
$r_T$	Forward slope resistance, max	m $\Omega$	0.030	$5000\text{ A} < I_T < 14000\text{ A}$
<b>BLOCKING</b>				
$I_{RRM}$	Repetitive peak reverse current, max	mA	50	$T_j=T_{j\text{ max}};$ $V_R=V_{RRM}$
<b>SWITCHING</b>				
$Q_{rr}$	Total recovered charge, max	$\mu\text{C}$	1150	$T_j=T_{j\text{ max}}; I_{FM}=1000\text{ A};$ $di_{FM}/dt=-30\text{ A}/\mu\text{s};$
			720	$T_j=T_{j\text{ max}}; I_{FM}=1000\text{ A};$ $di_{FM}/dt=-10\text{ A}/\mu\text{s};$
<b>THERMAL</b>				
$R_{thjc}$	Thermal resistance, junction to case, max	$^\circ\text{C}/\text{W}$	0.0050	Double side cooled
$R_{thjc-A}$			0.0070	Anode side cooled
$R_{thjc-K}$			0.0150	Cathode side cooled
$R_{thck}$	Thermal resistance, case to heatsink, max		0.0035	Direct Current
<b>MECHANICAL</b>				
w	Weight, typ	g	110	
$D_s$	Surface creepage distance	mm (inch)	2.0 (0.079)	
$D_a$	Air strike distance	mm (inch)	2.0 (0.079)	

### PART NUMBERING GUIDE

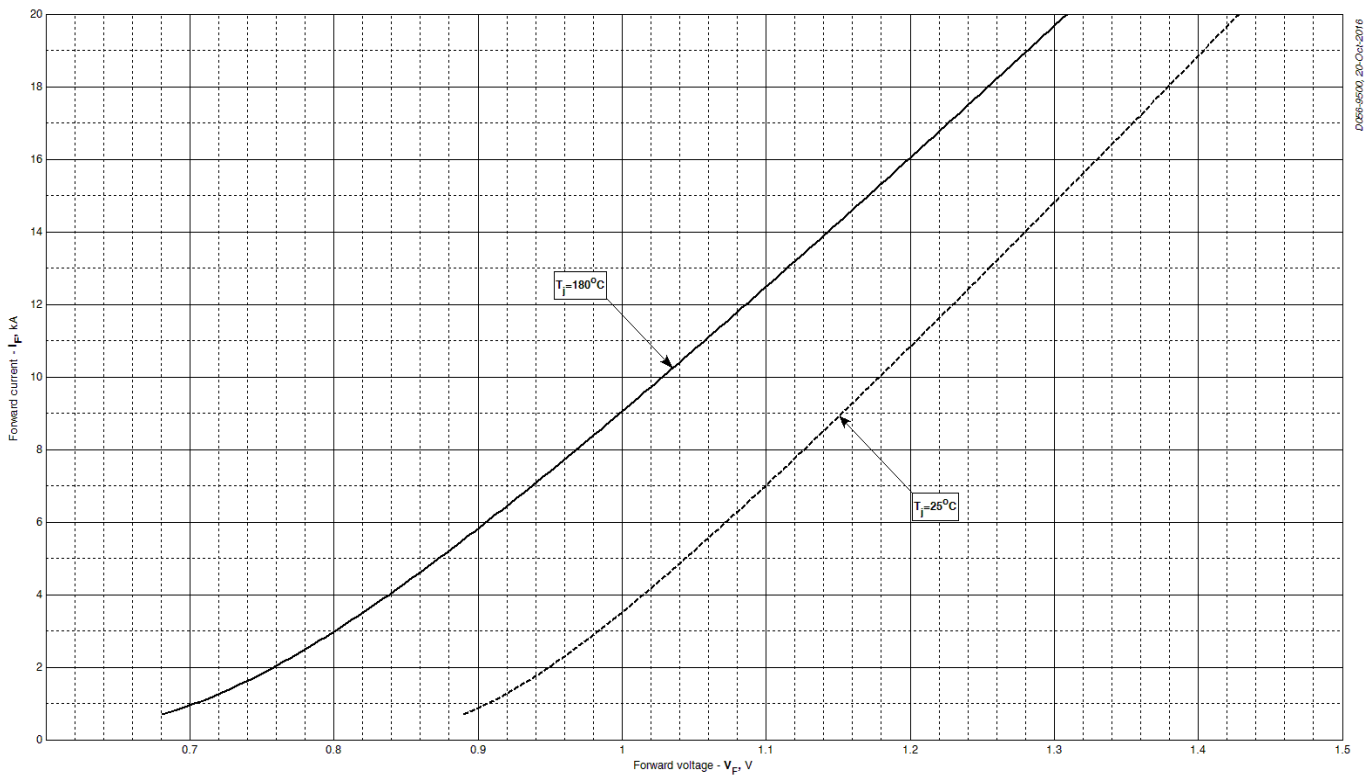
D	056	9500	4	N
1	2	3	4	

1. Design version
2. Average forward current, A
3. Voltage code
4. Ambient conditions: N – normal



All dimensions in millimeters (inches)

The information contained herein is confidential and protected by Copyright.  
In the interest of product improvement, Proton-Electrotex reserves the right to change data sheet without notice.



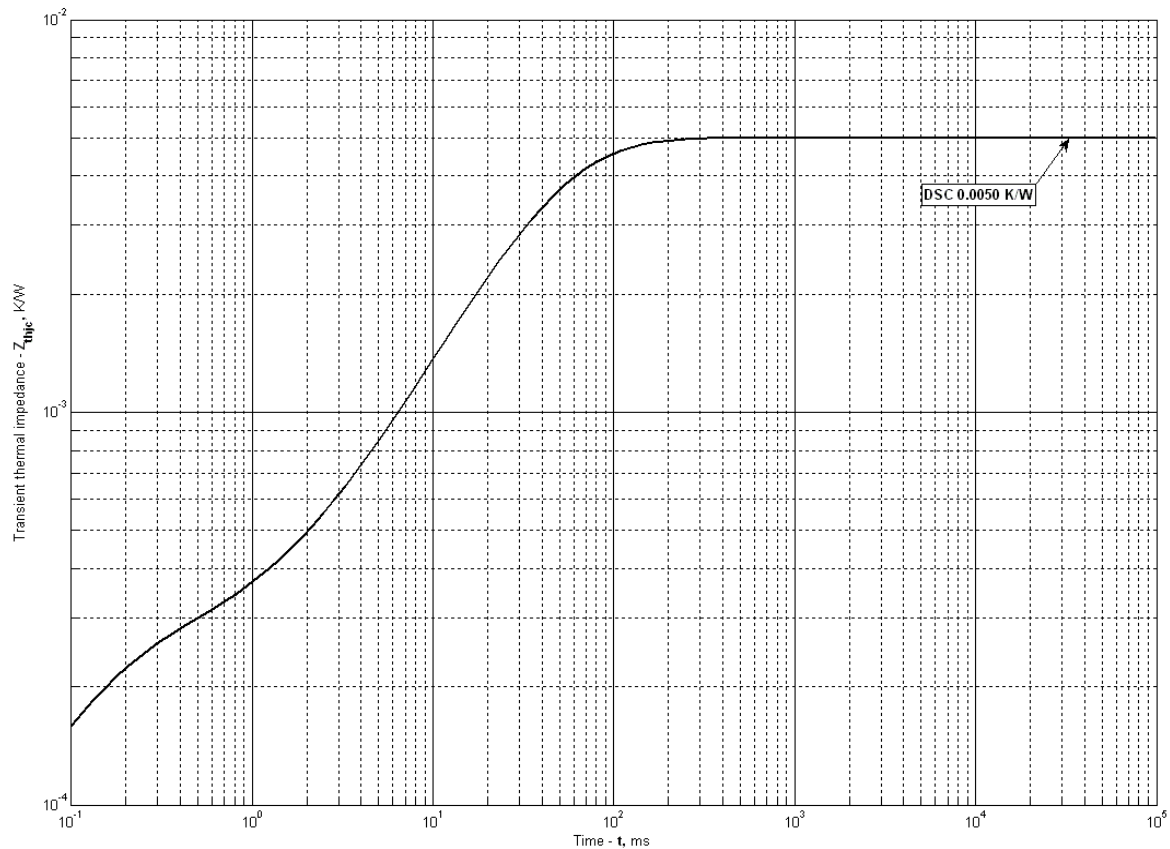
**Fig 1 – Forward characteristics of Limit device**

Analytical function for Forward characteristic:

$$V_F = A + B \cdot i_F + C \cdot \ln(i_F + 1) + D \cdot \sqrt{i_F}$$

	Coefficients for max curves	
	$T_j = 25^\circ\text{C}$	$T_j = T_{j\text{max}}$
<b>A</b>	0.907474	0.779908
<b>B</b>	0.019903	0.028250
<b>C</b>	0.069432	0.147664
<b>D</b>	-0.037894	-0.080592

**Forward characteristic model (see Fig. 1).**



**Fig 2 – Transient thermal impedance**

Analytical function for Transient thermal impedance junction to case  $Z_{thjc}$  for DC:

$$Z_{thjc} = \sum_{i=1}^n R_i \left( 1 - e^{-\frac{t}{\tau_i}} \right)$$

Where  $i = 1$  to  $n$ ,  $n$  is the number of terms in the series.

$t$  = Duration of heating pulse in seconds.

$Z_{thjc}$  = Thermal resistance at time  $t$ .

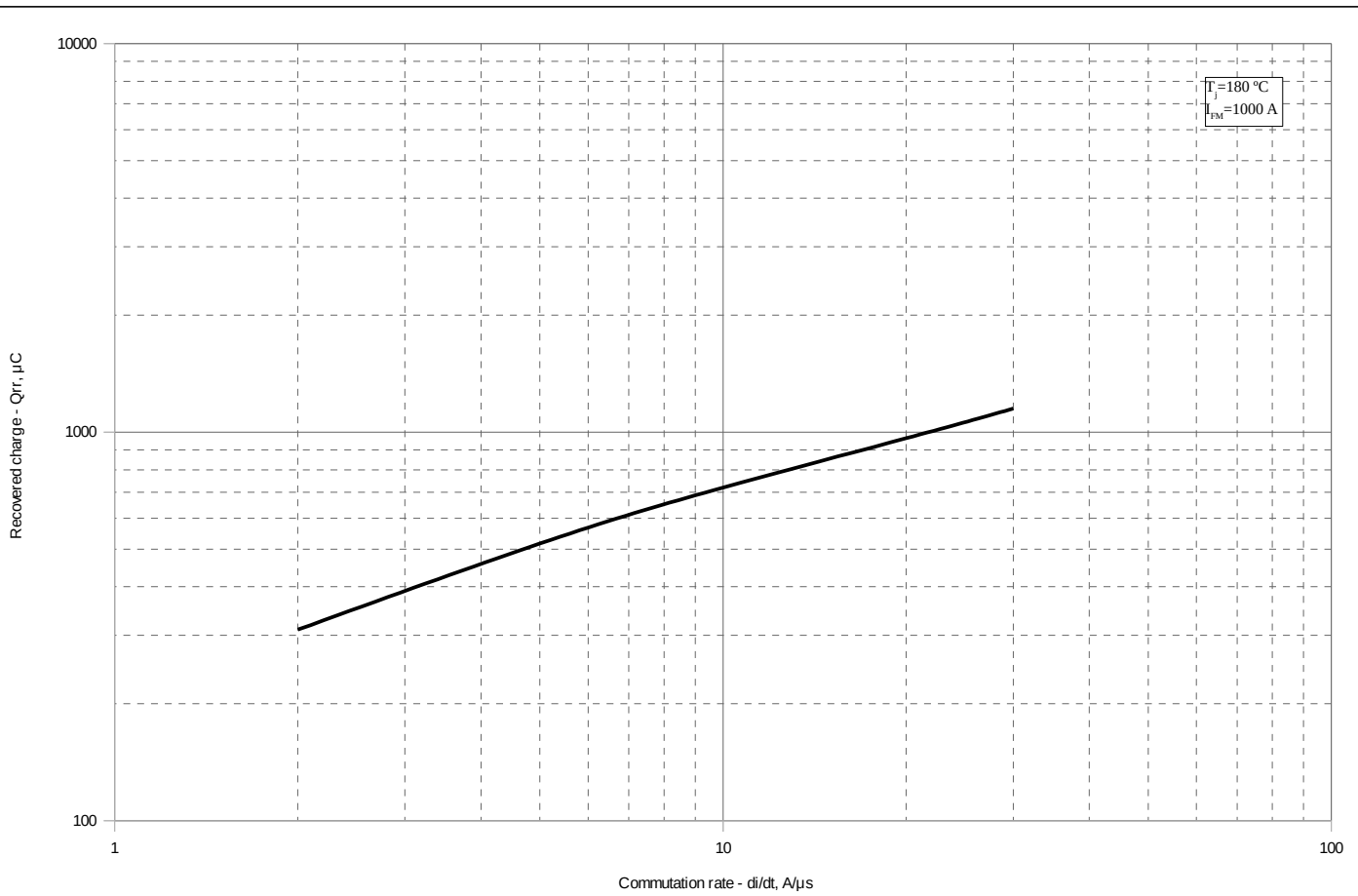
$R_i$  = Amplitude of  $p_{th}$  term.

$\tau_i$  = Time constant of  $r_{th}$  term.

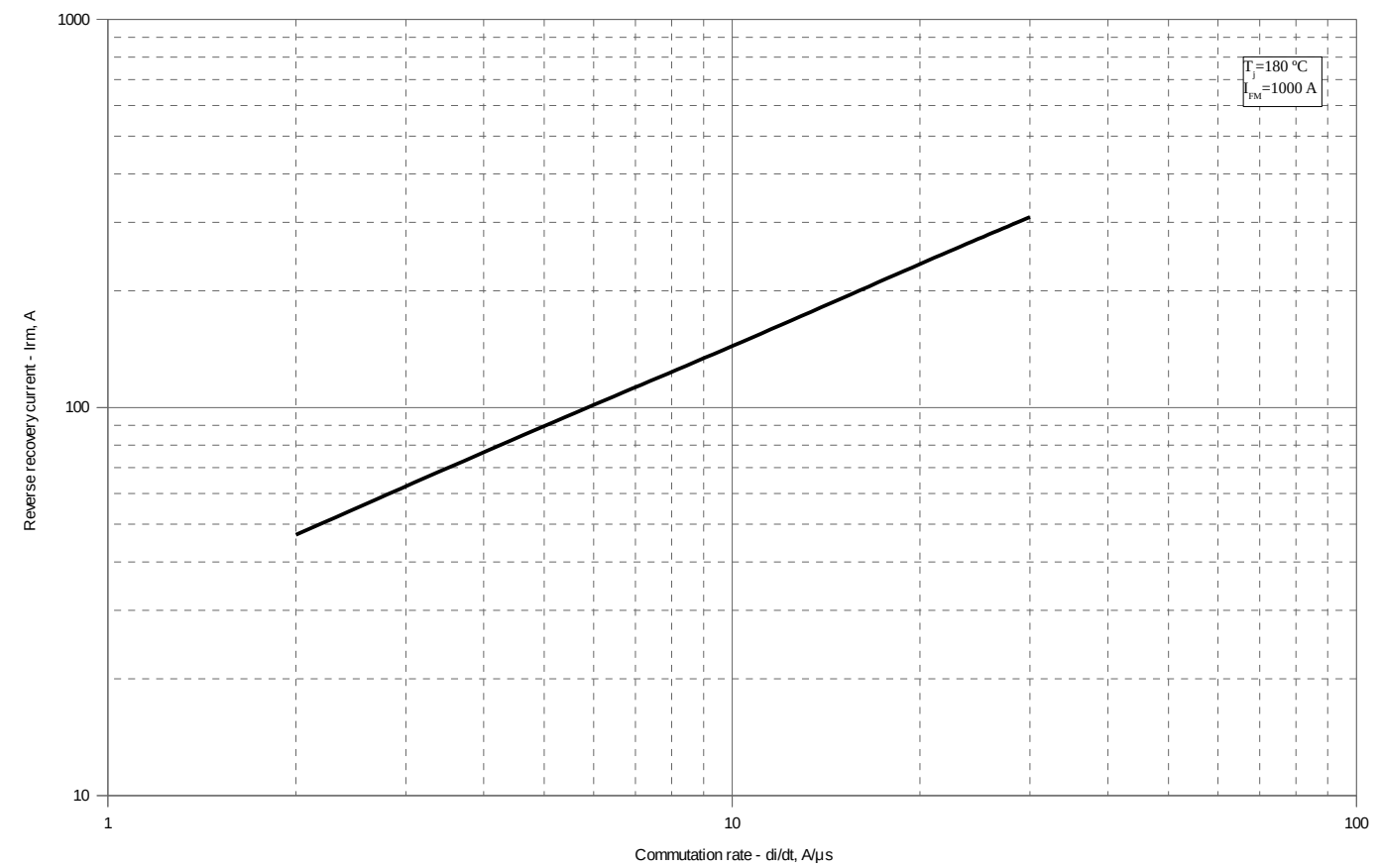
DC Double side cooled

$i$	1	2	3	4	5	6
$R_i, K/W$	0.0009858	0.003751	0.00001625	0.00001224	0.0001735	0.00006128
$\tau_i, s$	0.07476	0.03287	0.007701	0.001065	0.0001313	0.00005139

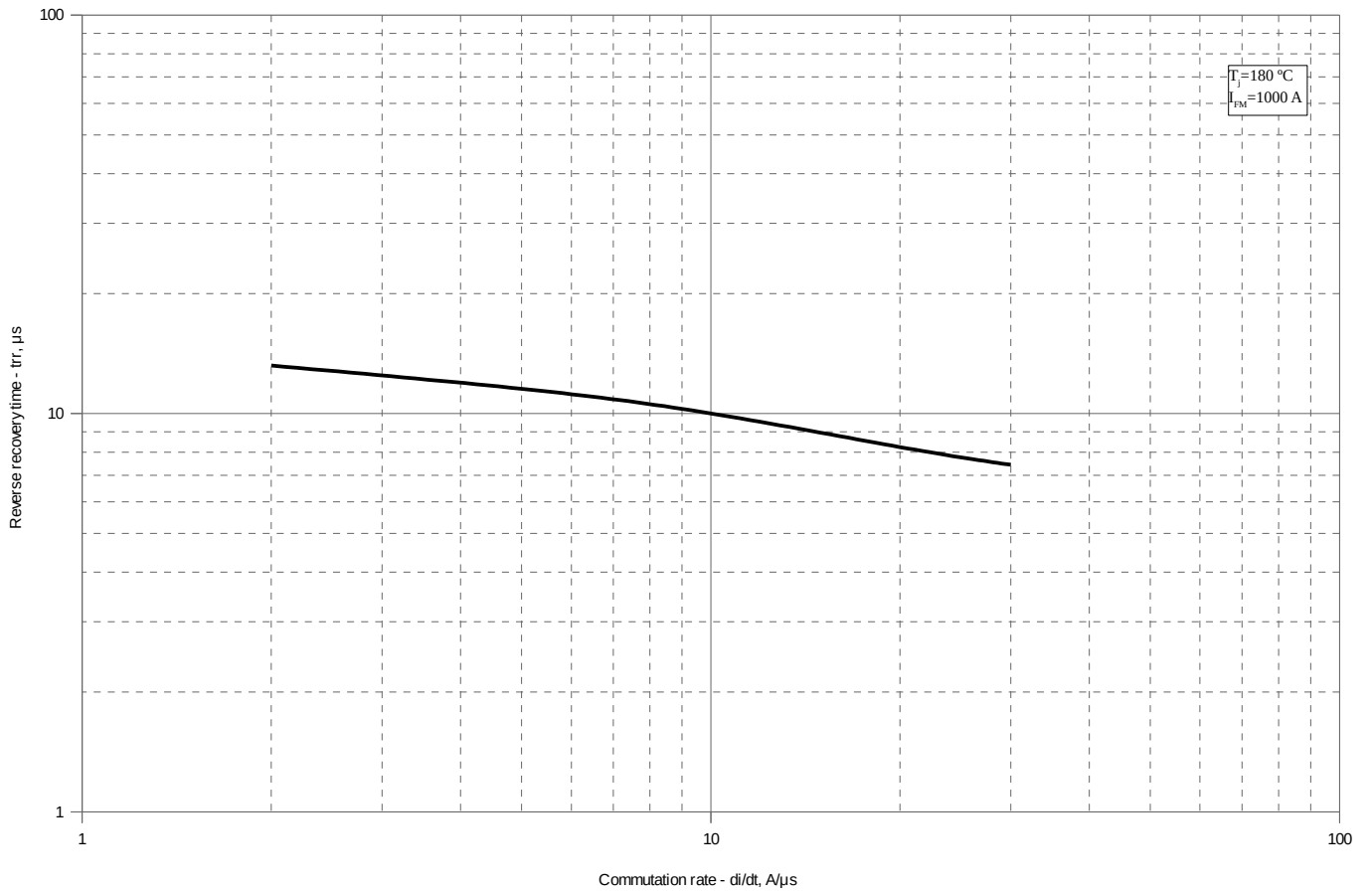
**Transient thermal impedance junction to case  $Z_{thjc}$  model (see Fig. 2)**



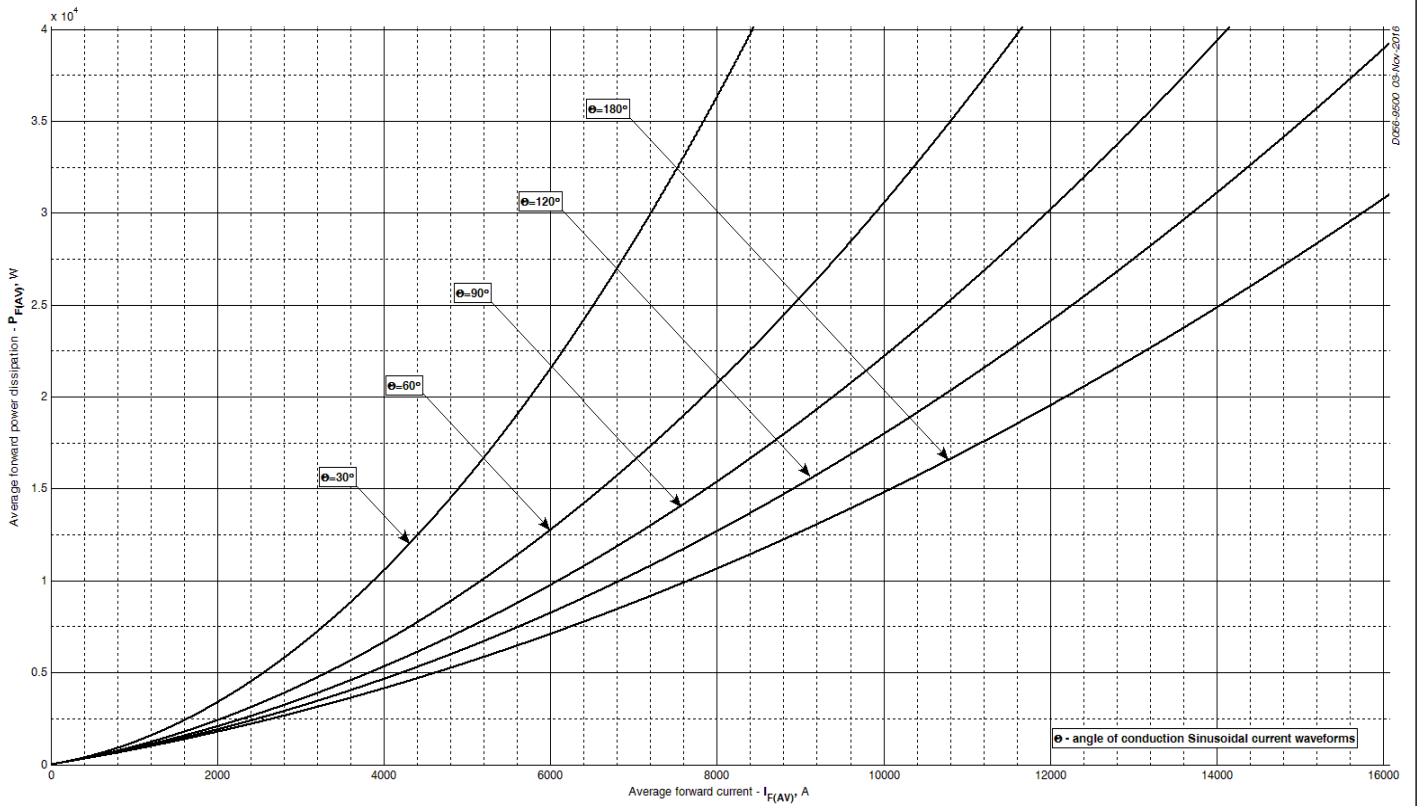
**Fig 3 - Recovered charge,  $Q_{rr}$**



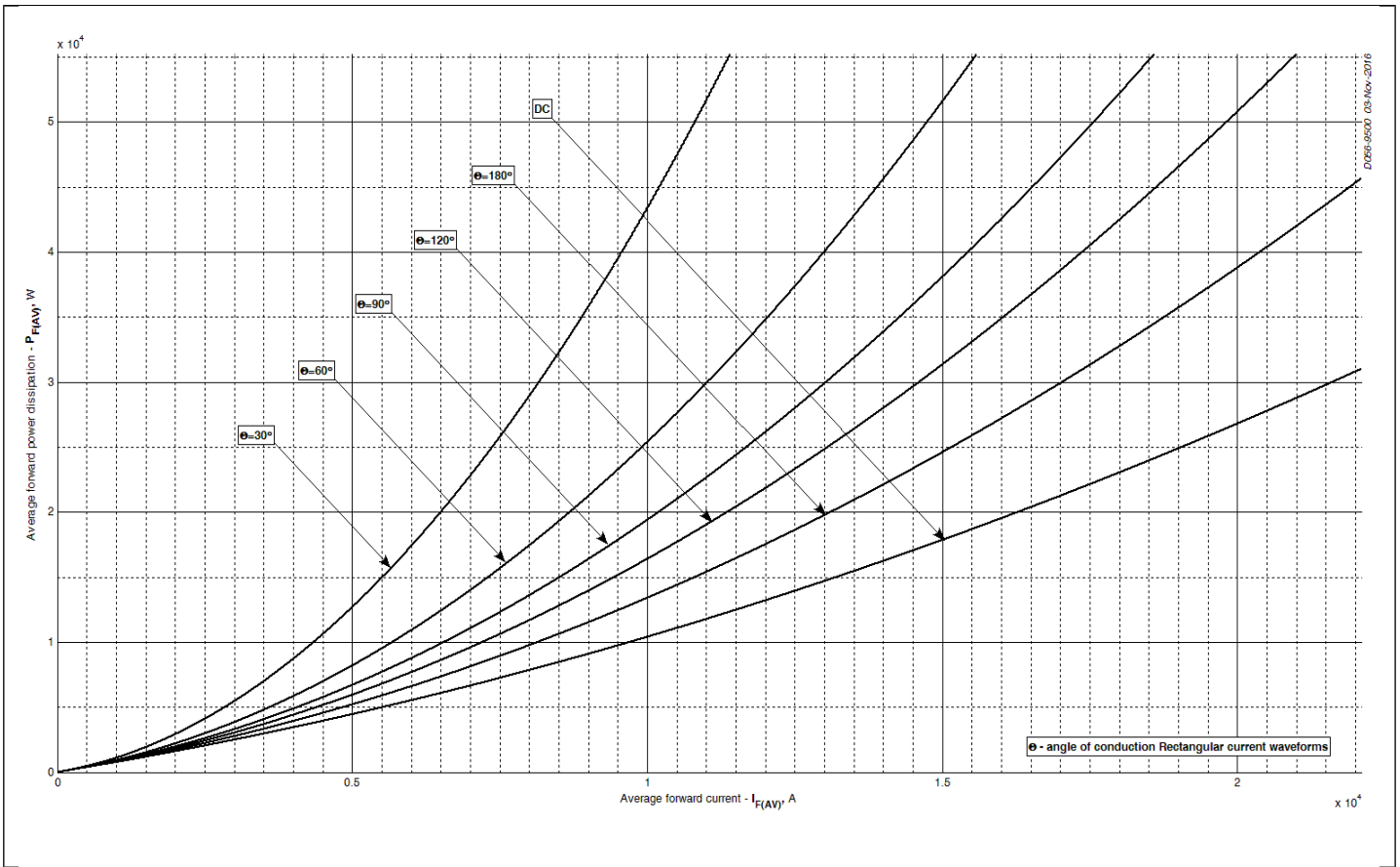
**Fig 4 – Peak reverse recovery current,  $I_{rm}$**



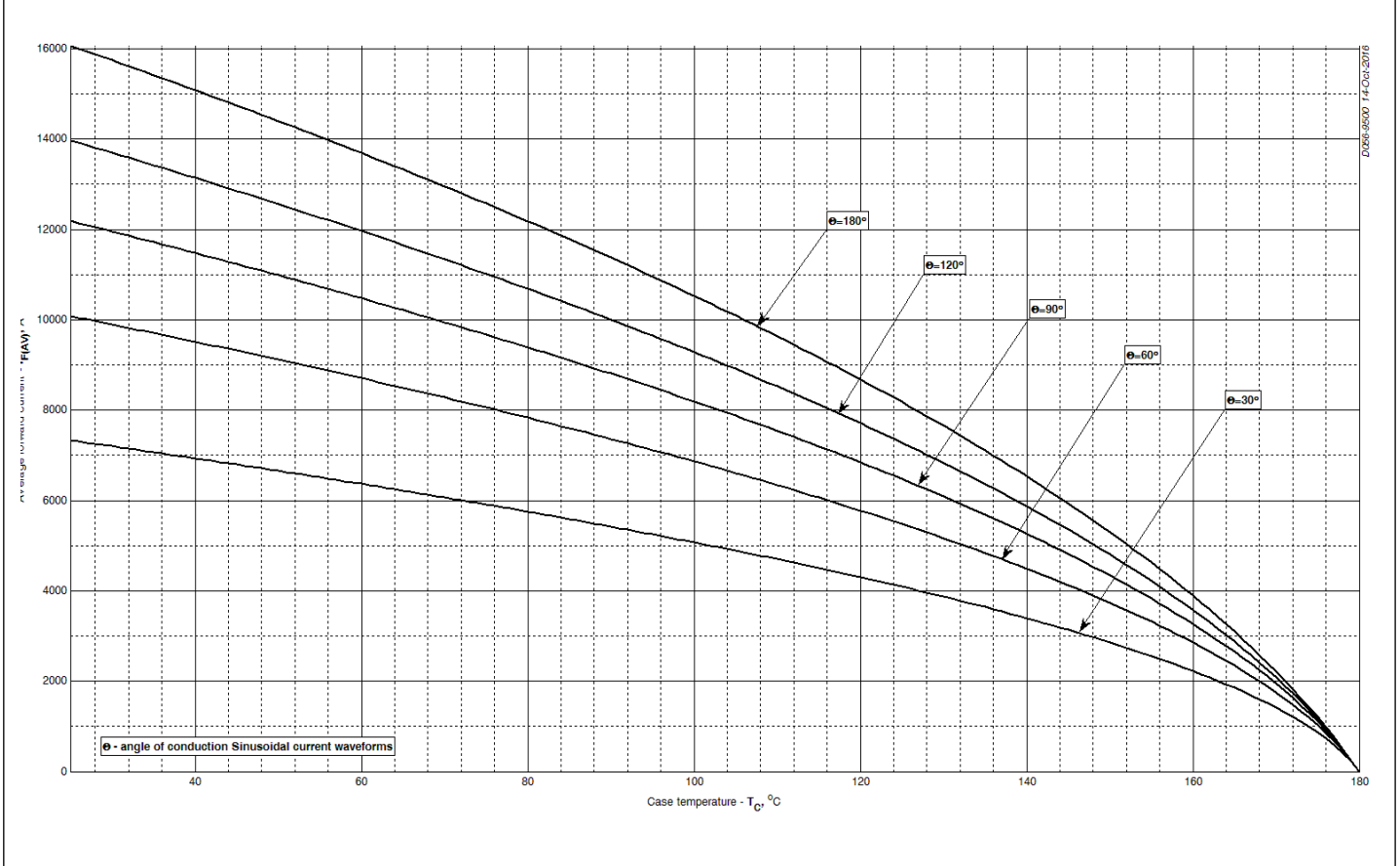
**Fig 5 – Maximum recovery time,  $t_{rr}$  (linear)**



**Fig 6 – Mean forward power dissipation  $P_{FAV}$  vs. Mean forward current  $I_{FAV}$  for sinusoidal current waveforms at different conduction angles ( $f=50\text{Hz}$ , DSC)**

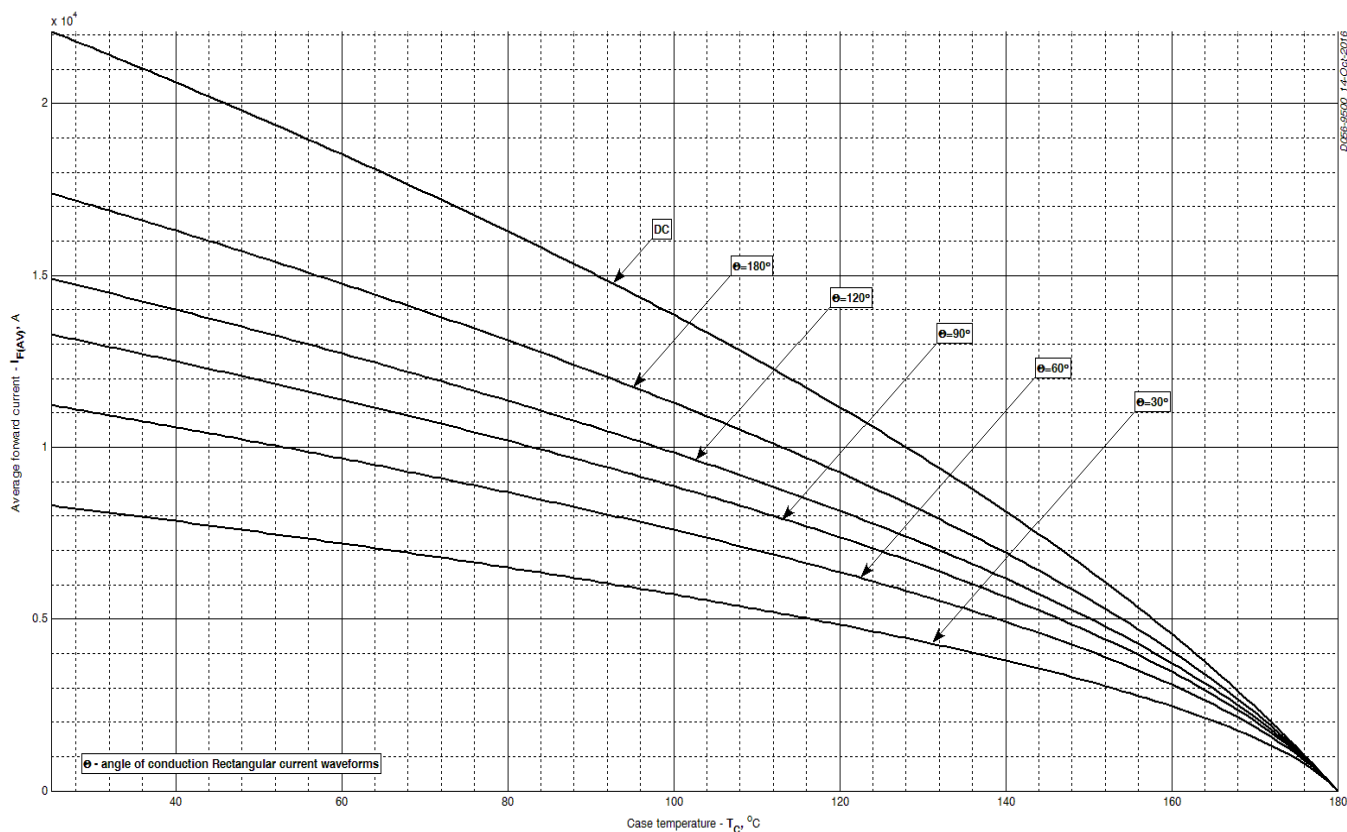


**Fig 7 – Mean forward power dissipation  $P_{FAV}$  vs. Mean forward current  $I_{FAV}$  for rectangular current waveforms at different conduction angles and for DC ( $f=50\text{Hz}$ , DSC)**

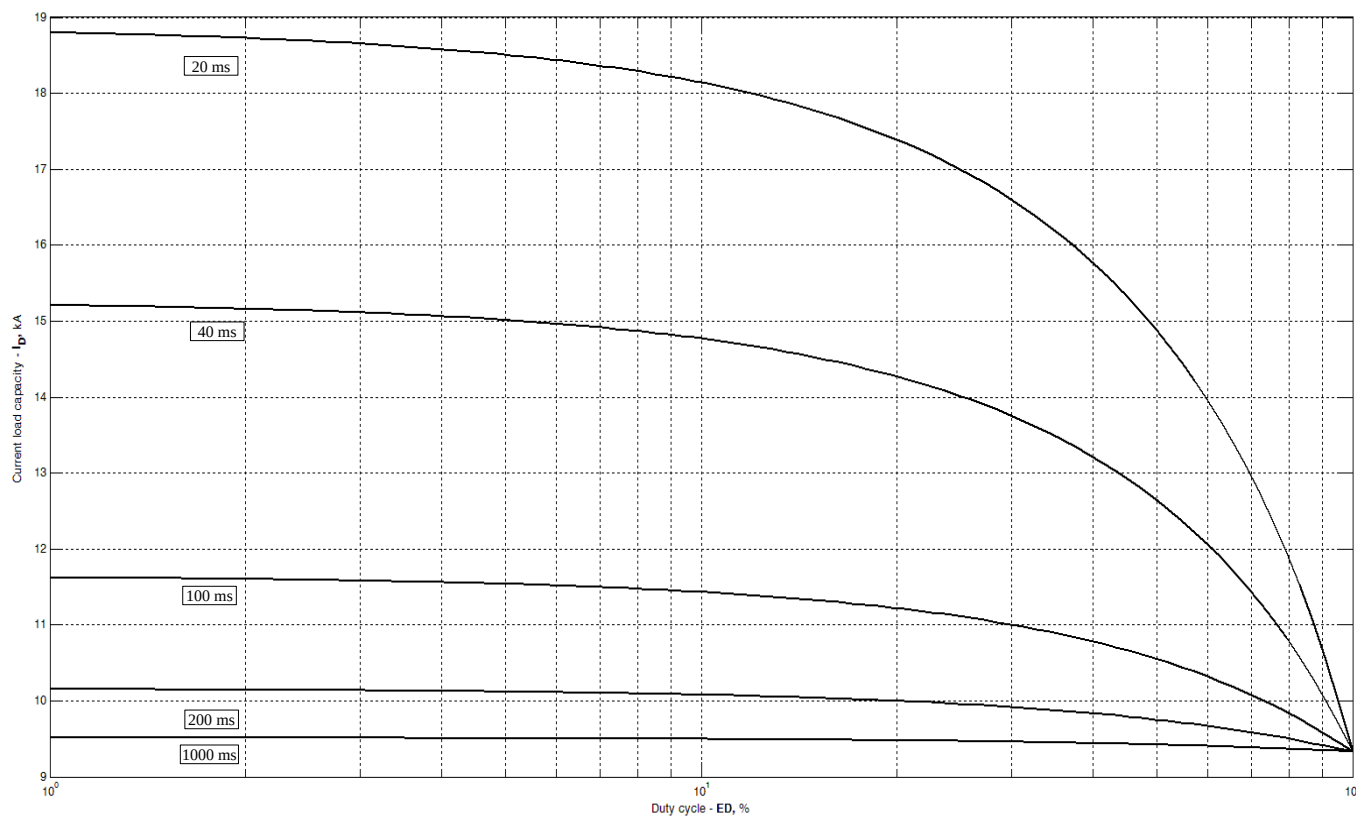


**Fig 8 - Mean forward current  $I_{FAV}$  vs. Case temperature  $T_C$  for sinusoidal current waveforms at different conduction angles ( $f=50\text{Hz}$ , DSC)**

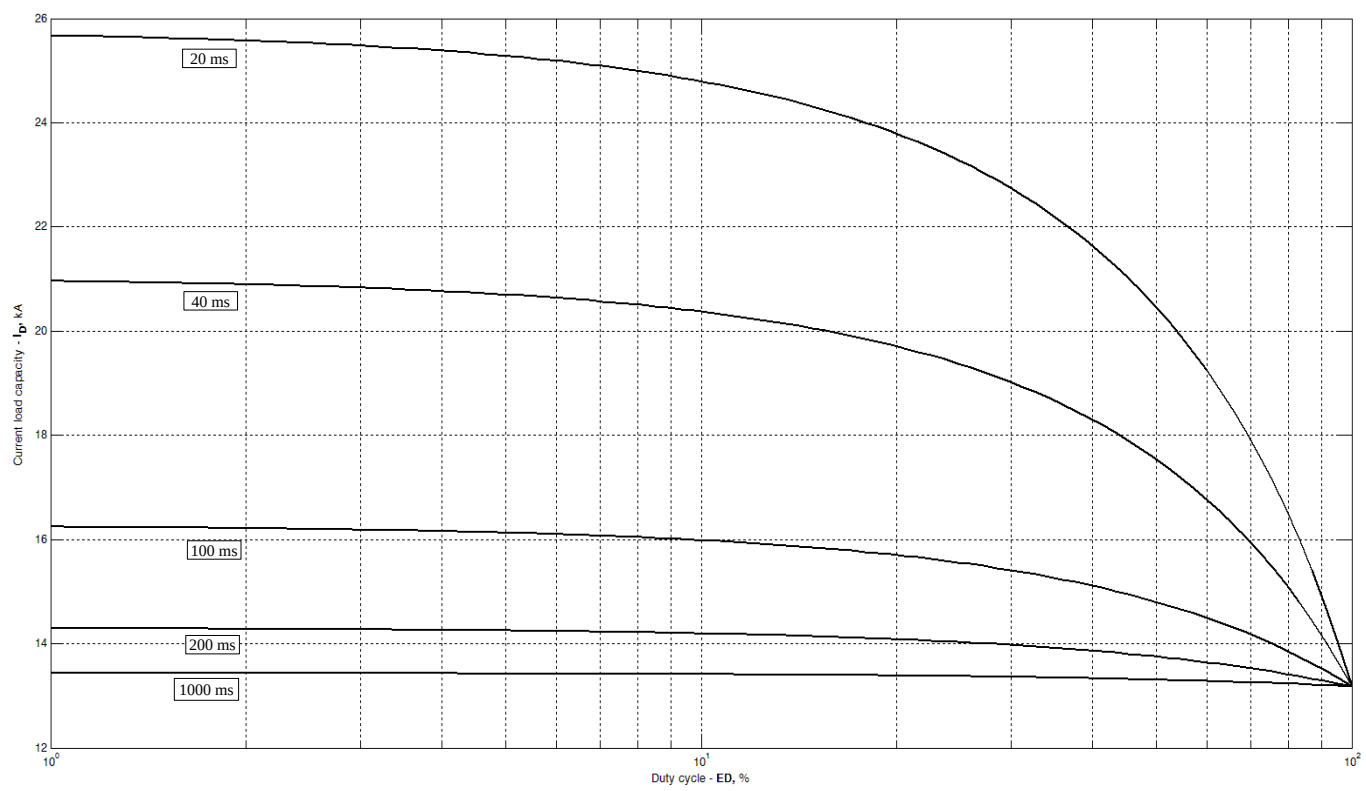




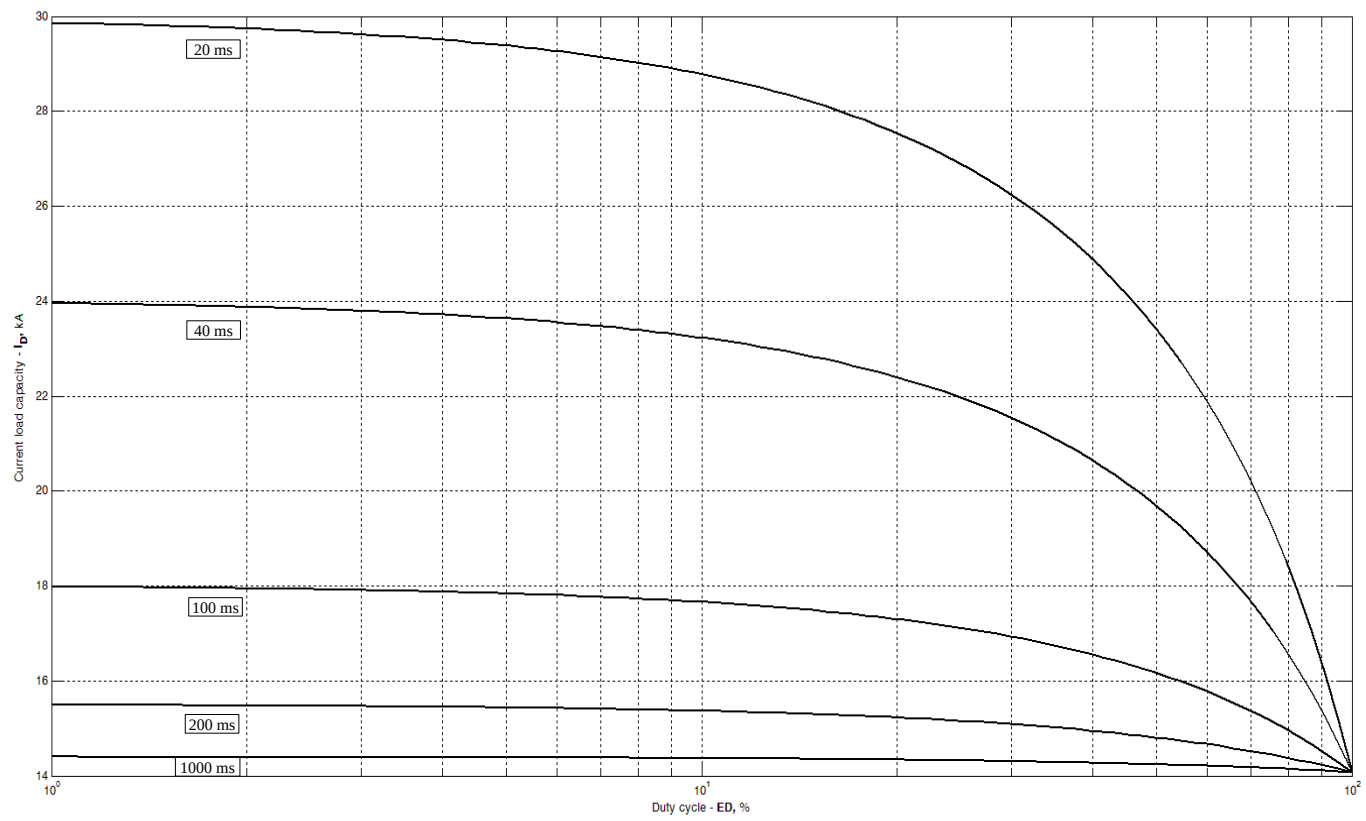
**Fig 9 – Mean forward current  $I_{FAV}$  vs. Case temperature  $T_c$  for rectangular current waveforms at different conduction angles and for DC ( $f=50\text{Hz}$ , DSC)**



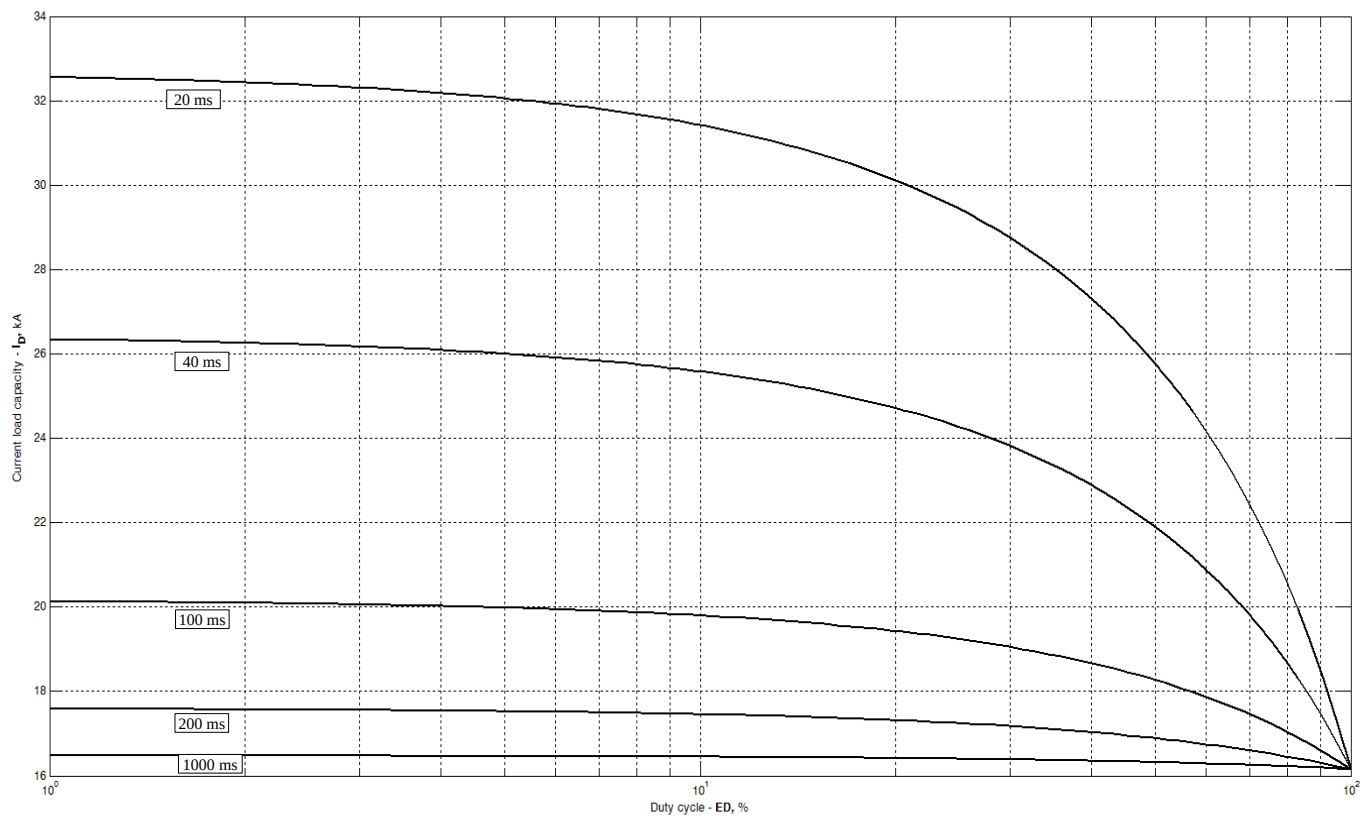
**Fig 10 – Current load capability ( $f=1000$  Hz, square wave,  $T_c = 40^{\circ}\text{C}$ )**



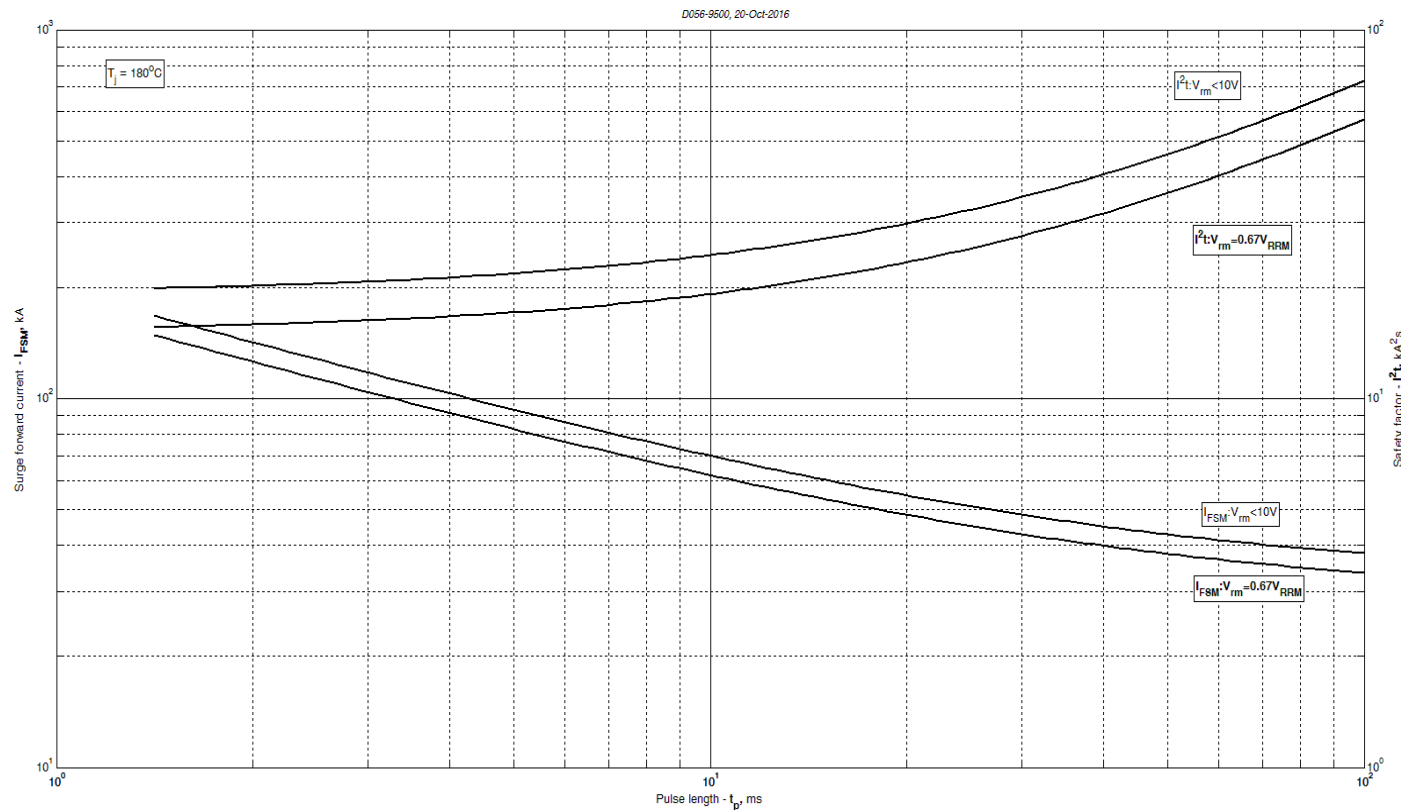
**Fig 11 – Current load capability (f=1000 Hz, square wave, T<sub>c</sub> = 60 °C)**



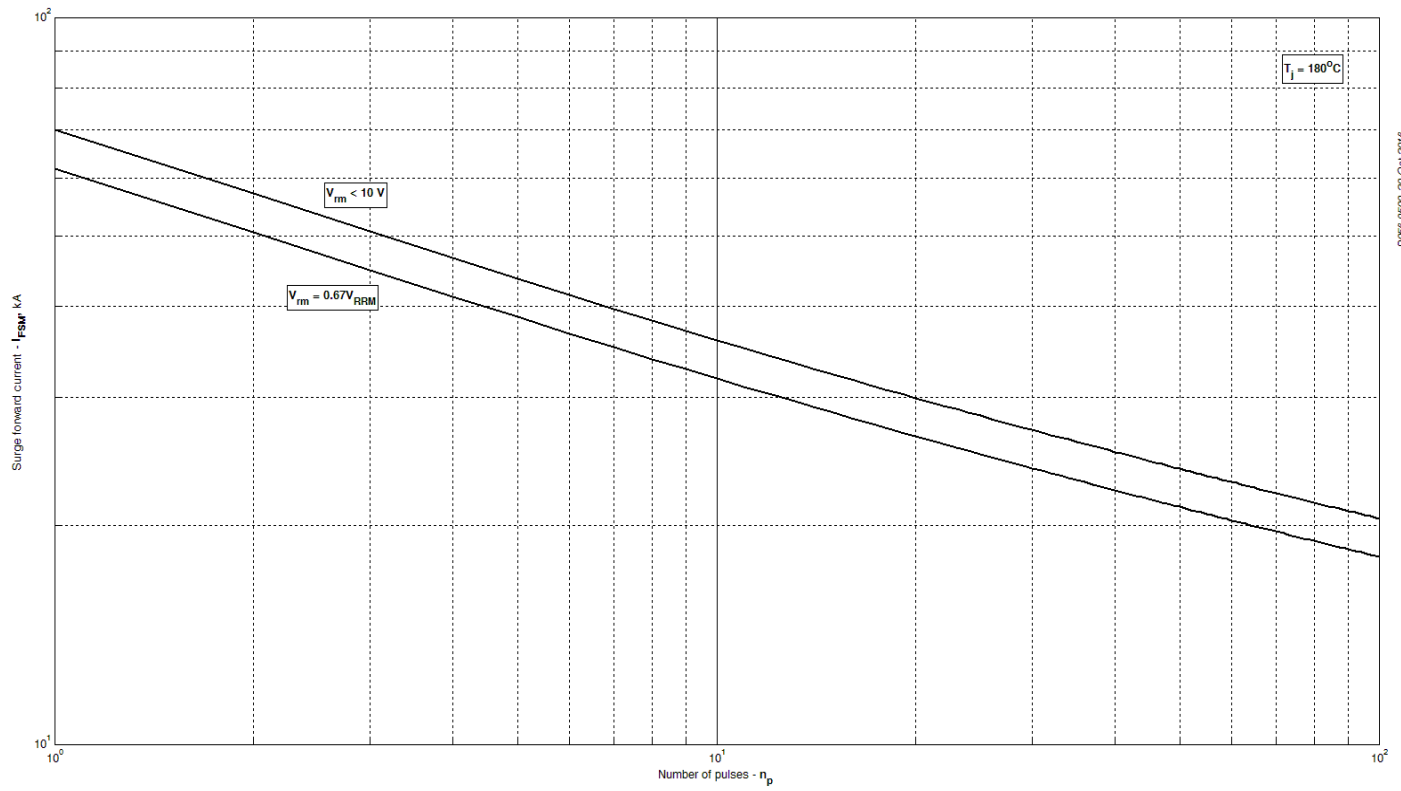
**Fig 12 – Current load capability (f=1000 Hz, square wave, T<sub>c</sub> = 70 °C)**



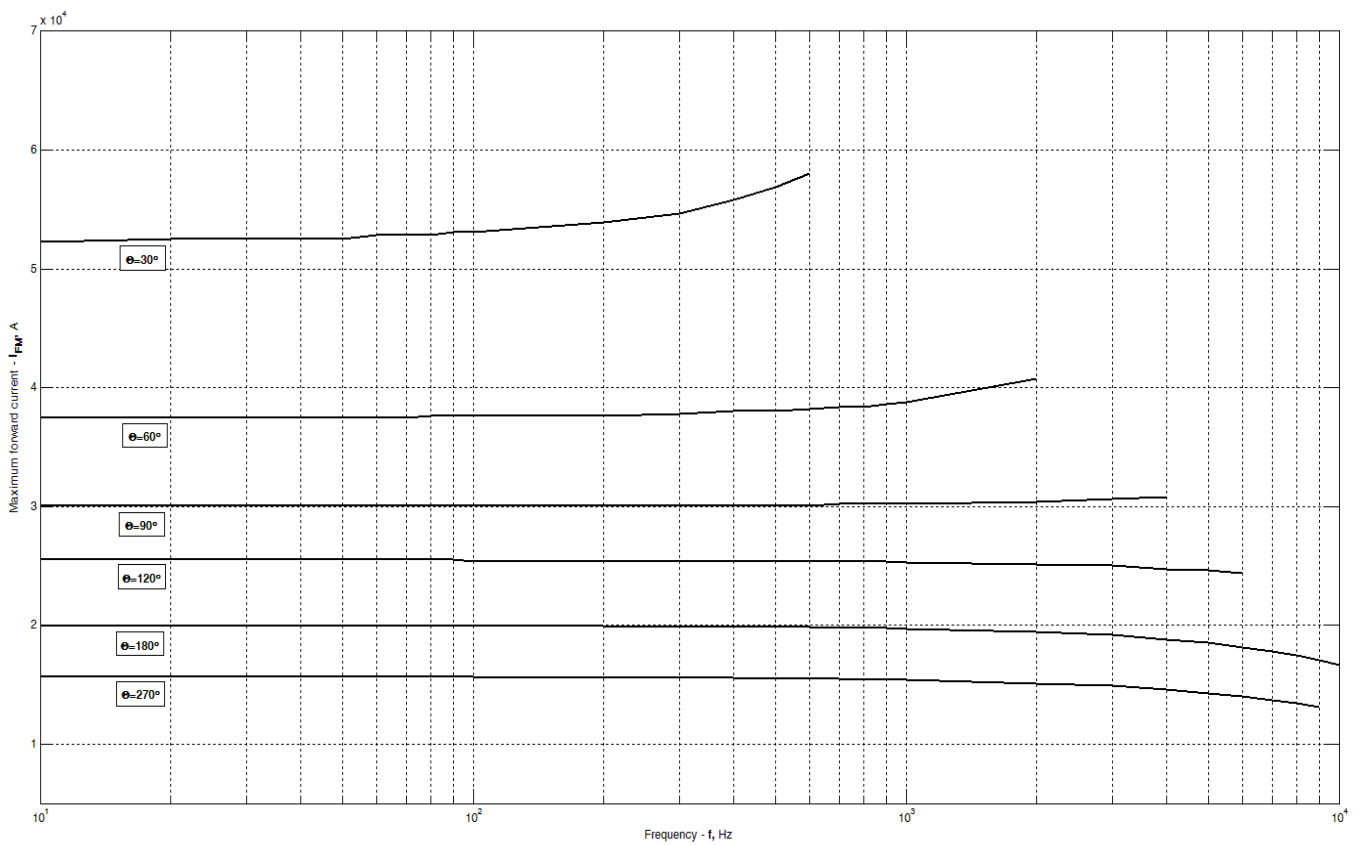
**Fig 13 – Current load capability (f=1000 Hz, square wave,  $T_c = 80\text{ }^\circ\text{C}$ )**



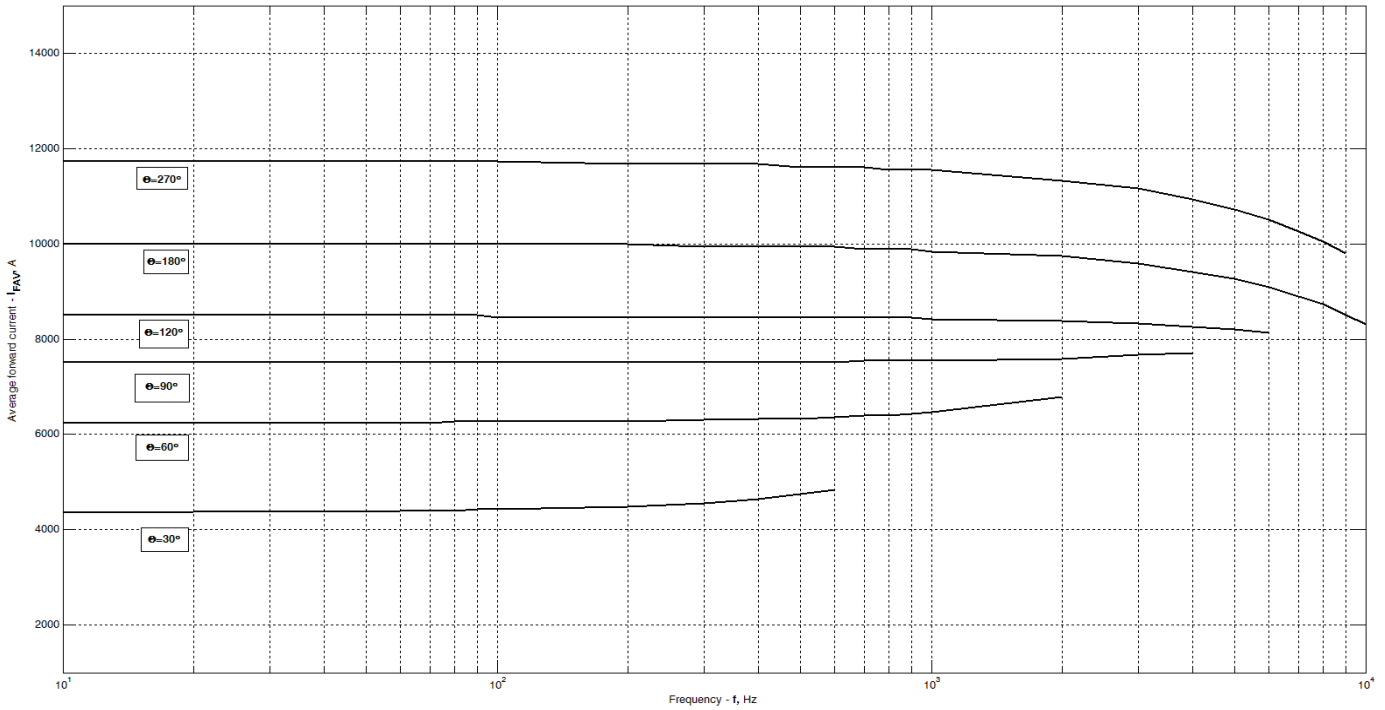
**Fig 14 – Maximum surge and  $I^2t$  ratings**



**Fig 15 – Maximum surge ratings**



**Fig 16 – Maximum forward current vs. frequency, trapezoid waveform,  $T_C=85\text{ }^\circ\text{C}$ ,  $di_F/dt=\pm 500\text{ A}/\mu\text{s}$ ,  $V_R=100\text{ V}$**



**Fig 17 –Average forward current vs. frequency, trapezoid waveform,  
 $T_c=85^\circ\text{C}$ ,  $di_F/dt=\pm 500\text{ A}/\mu\text{s}$ ,  $V_R=100\text{ V}$**