

62mm Module with Ultrafast switching speed IGBT and Fast recovery diode.

Feature

- 200A/1200V, $V_{CE(sat)(typ.)} = 3.2V@200A$
- Ultrafast switching speed
- Excellent short circuit ruggedness

Applications

- Inverter welding
- Inductive heating
- Uninterrupted Power Supply(UPS)

Appearance



Maximum Ratings of IGBT ($T_{vj}=25^{\circ}C$ unless otherwise noted)

Items	Symbol	Conditions	Maximum Rating	Units
Collector-emitter voltage	V_{CES}		1200	V
Gate-emitter voltage	V_{GES}		± 20	V
Collector current	I_C	$T_{vj}=25^{\circ}C$	400	A
		$T_{vj}=100^{\circ}C$	200	A
Pulsed collector current	I_{CM}	$t_p=1ms$	400	A
Short circuit current	I_{sc}	$V_{GE} \leq 15V, V_{CC}=600V, t_p \leq 10\mu s$ $V_{CEmax}=V_{CES}-L_{sCE} \cdot di/dt$	1400	A
Maximum power dissipation	P_D	$T_c=25^{\circ}C, T_{vj}=150^{\circ}C$	1395	W

Electrical Characteristics of IGBT ($T_{vj}=25^{\circ}C$ unless otherwise noted)

Items	Symbol	Conditions	Min.	typ.	Max.	Units
Collector-emitter breakdown voltage	V_{CES}	$V_{GE}=0V, I_C=250\mu A$	1200			V
Collector -emitter leakage current	I_{CES}	$V_{CE}=1200V, V_{GE}=0V$			5	mA
Gate leakage current, forward	I_{GES}	$V_{GE}=20V, V_{CE}=0V$			400	nA
		$V_{GE}=-20V, V_{CE}=0V$			-400	nA
Gate threshold voltage	$V_{GE(th)}$	$V_{GE}=V_{CE}, I_C=8mA$	5.0	5.9	6.5	V
Collector-emitter saturation voltage	$V_{CE(sat)}$	$V_{GE}=15V, I_C=200A, T_{vj}=25^{\circ}C$		3.2	3.6	V
		$V_{GE}=15V, I_C=200A, T_{vj}=125^{\circ}C$		3.9		V
Integrated gate resistor	R_{Gint}	$f=1M; V_{pp}=1V$		2.50		Ω
Input capacitance	C_{ies}	$V_{CE}=25V$		13		nF
Output capacitance	C_{oes}	$V_{GE}=0V$		2.2		nF
Reverse transfer capacitance	C_{res}	$f=1MHz$		0.85		nF
Total gate charge	Q_g	$V_{CC}=600V, V_{GE}=15V, I_C=75A$		2100		nC
Turn-on delay time	$t_{d(on)}$	$V_{CC}=600V$		71		ns
Rise time	t_r	$V_{GE}=\pm 15V$		99		ns
Turn-off delay time	$t_{d(off)}$	$I_C=200A$		400		ns
Fall time	t_f	$R_G=4\Omega$		117		ns
Turn-on energy loss per pulse	E_{on}	Inductive Load		7.9		mJ
Turn-off energy loss per pulse	E_{off}	$T_{vj}=25^{\circ}C$		14.6		mJ
Turn-on delay time	$t_{d(on)}$	$V_{CC}=600V$		79		ns
Rise time	t_r	$V_{GE}=\pm 15V$		102		ns
Turn-off delay time	$t_{d(off)}$	$I_C=200A$		435		ns
Fall time	t_f	$R_G=4\Omega$		139		ns
Turn-on energy loss per pulse	E_{on}	Inductive Load		12		mJ
Turn-off energy loss per pulse	E_{off}	$T_{vj}=125^{\circ}C$		14.9		mJ
Temperature under switching conditions	$T_{vj op}$		-55		150	$^{\circ}C$

Maximum Ratings of Diode

Items	Symbol	Conditions	Maximum Rating	Units
Repetitive peak reverse voltage	V_{RRM}	$T_{vj}=25^{\circ}C$	1200	V
Diode continuous forward current	I_F	$T_{vj}=25^{\circ}C$	400	A
		$T_{vj}=100^{\circ}C$	200	A
Diode maximum forward current	I_{FM}	$t_p=1ms, T_{vj}=25^{\circ}C$	300	A

Electrical Characteristics of Diode ($T_{vj}=25^{\circ}C$ unless otherwise noted)

Items	Symbol	Conditions	Min.	typ.	Max.	Units
Diode forward voltage	V_F	$I_F=200A, T_{vj}=25^{\circ}C$		2.9	3.2	V
		$I_F=200A, T_{vj}=125^{\circ}C$		2.05		V
Diode reverse recovery time	t_{rr}	$V_{CE}=600V$		90		ns
Diode peak reverse recovery current	I_{rr}	$I_F=200A$		140		A
Diode reverse recovery charge	Q_{rr}	$dI_F/dt=2780A/\mu s$		13		nC
Reverse recovery energy	E_{rec}	$T_{vj}=25^{\circ}C$		2.4		mJ
Diode reverse recovery time	t_{rr}	$V_{CE}=600V$		95		ns
Diode peak reverse recovery current	I_{rr}	$I_F=200A$		200		A
Diode reverse recovery charge	Q_{rr}	$dI_F/dt=2780A/\mu s$		32		nC
Reverse recovery energy	E_{rec}	$T_{vj}=125^{\circ}C$		7.70		mJ

Thermal Characteristics

Items	Symbol	Min.	typ.	Max.	Units
Thermal resistance, junction to case for IGBT	R_{thj-c}			0.09	$^{\circ}C/W$
Thermal resistance, junction to case for Diode	R_{thj-c}			0.15	$^{\circ}C/W$
Thermal resistance, case to sink	R_{thc-s}		0.10		$^{\circ}C/W$

Module Characteristics

Items	Symbol	Conditions	Min.	typ.	Max.	Units
Material of module baseplate				Cu		
Internal isolation		terminal to terminal		Al_2O_3		
Isolation test voltage	V_{isol}	RMS, $f = 50 Hz, t = 1 min.$	2.5			kV
Stray inductance module	L_{sCE}			30		nH
Mounting torque for modul mounting	M	Screw M6	3.0		5.0	Nm
Terminal connection torque	M	Screw M5	4.0		6.0	Nm
Storage temperature range	T_{STG}		-55		150	$^{\circ}C$
Weight of Module	W_t			315		g

Internal Circuit:

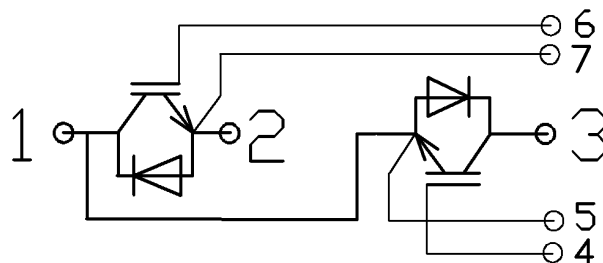

Representative Characteristics

Fig 1. Output characteristic IGBT

$$I_C = f(V_{CE}), V_{GE} = 15V$$

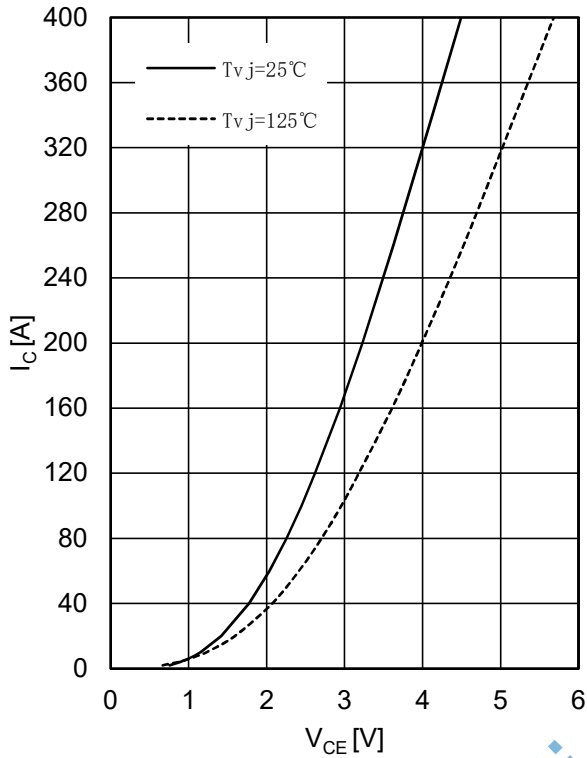

Fig 2. Output characteristic IGBT

$$I_C = f(V_{CE})$$

$$T_{vj} = 125^\circ C$$

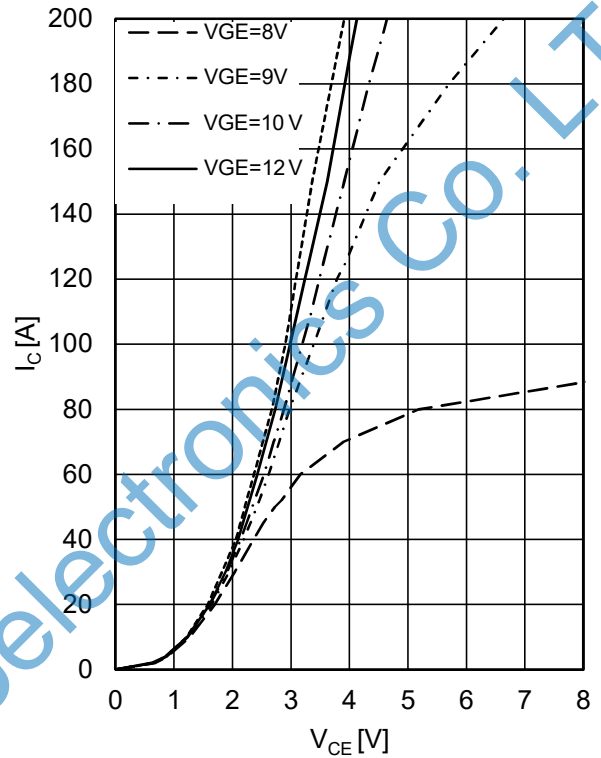

Fig 3. Transfer characteristic IGBT

$$I_C = f(V_{GE})$$

$$V_{CE} = 20V$$

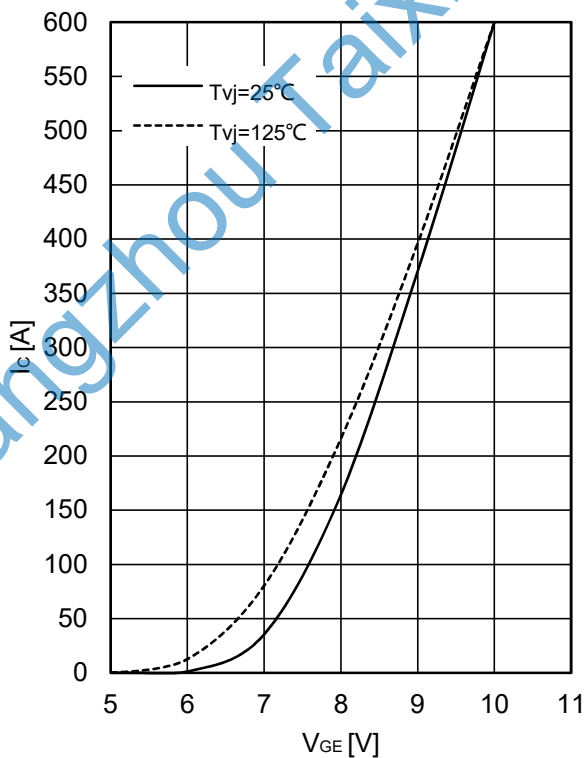

Fig 4. Switching losses IGBT

$$E_{on} = f(I_C), E_{off} = f(I_C)$$

$$V_{GE} = \pm 15V, R_G = 4.7\Omega, V_{CE} = 600V$$

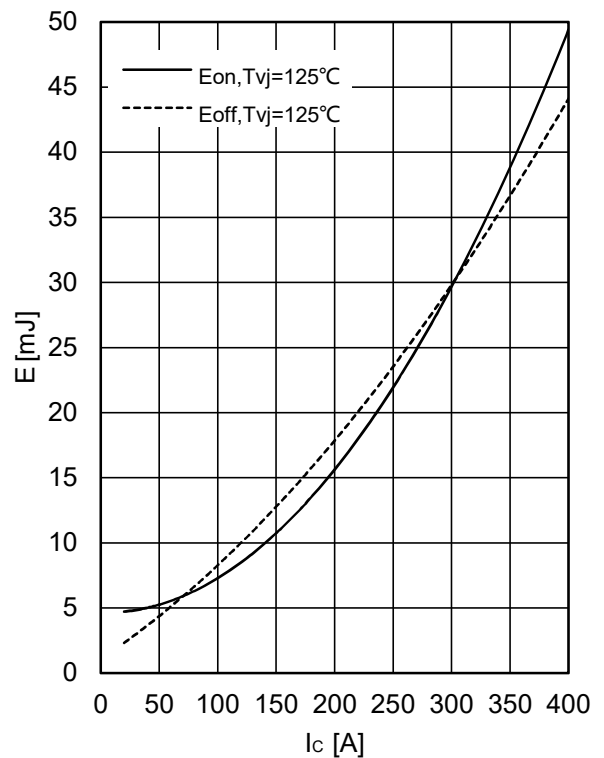

Fig 5. Switching losses IGBT

$$E_{on}=f(R_G), E_{off}=f(R_G),$$

$$V_{GE}=\pm 15V, I_C=200A, V_{CE}=600V$$

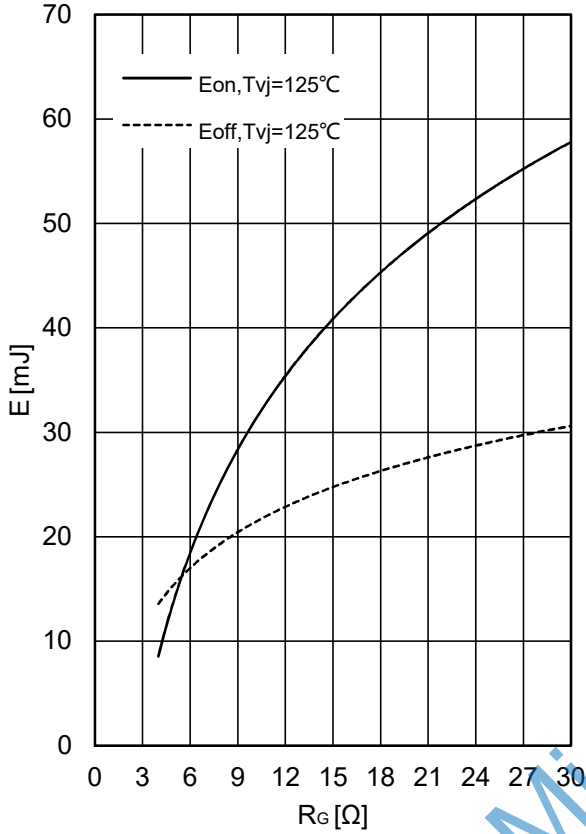

Fig 6. Transient thermal impedance IGBT

$$Z_{thjc}=f(t)$$

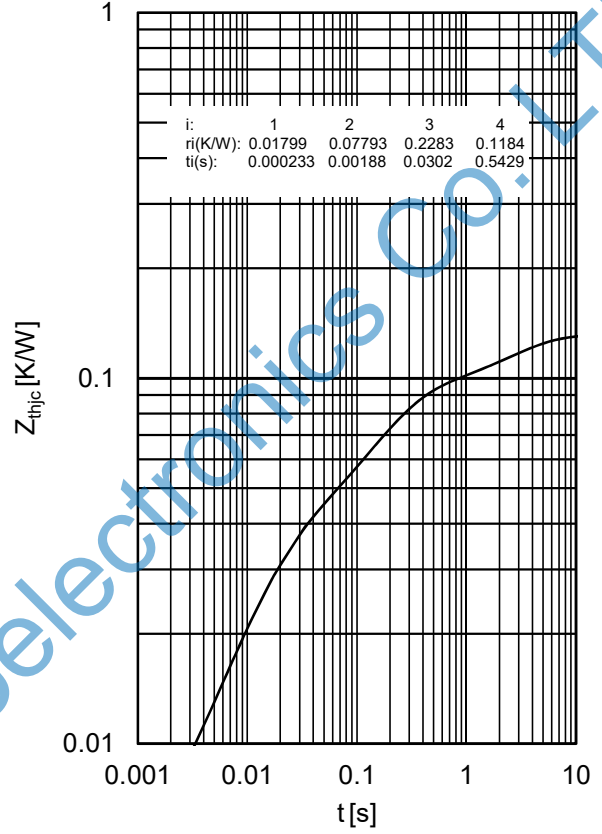

Fig 7. Reverse bias safe operating area IGBT,

$$I_C=f(V_{CE})$$

$$V_{GE}=\pm 15V, R_{Goff}=4.7\Omega, T_{vj}=125^\circ C$$

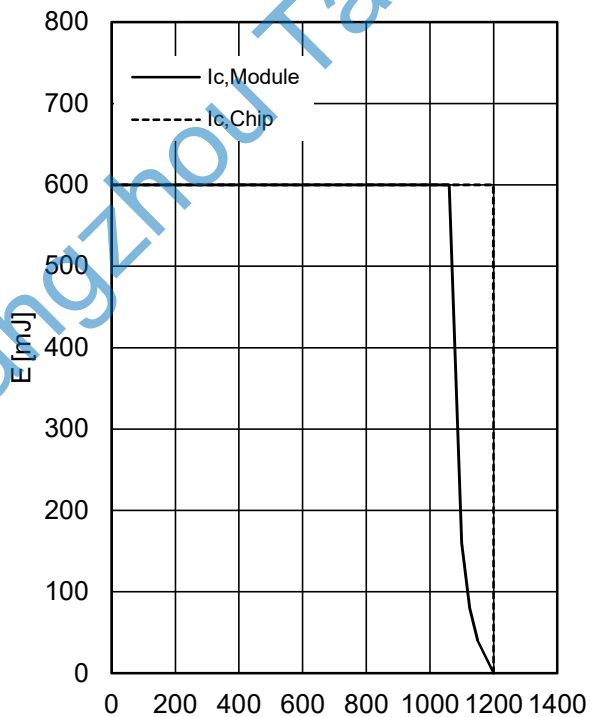
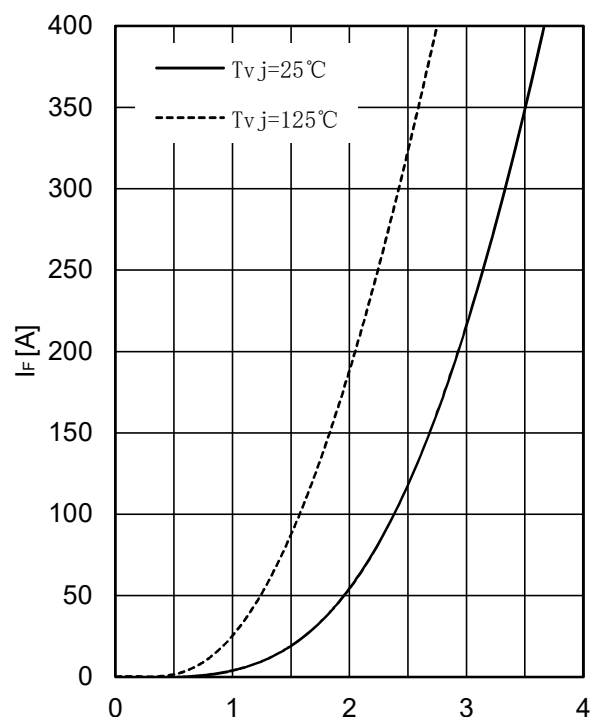

Fig 8. Forward characteristic of Diode

$$I_F=f(V_F)$$



V_{CE} [V]

V_F [V]

Fig 9. Switching losses Diode

$$E_{rec} = f(I_F)$$

$$R_G = 4.7\Omega, V_{CE} = 600V$$

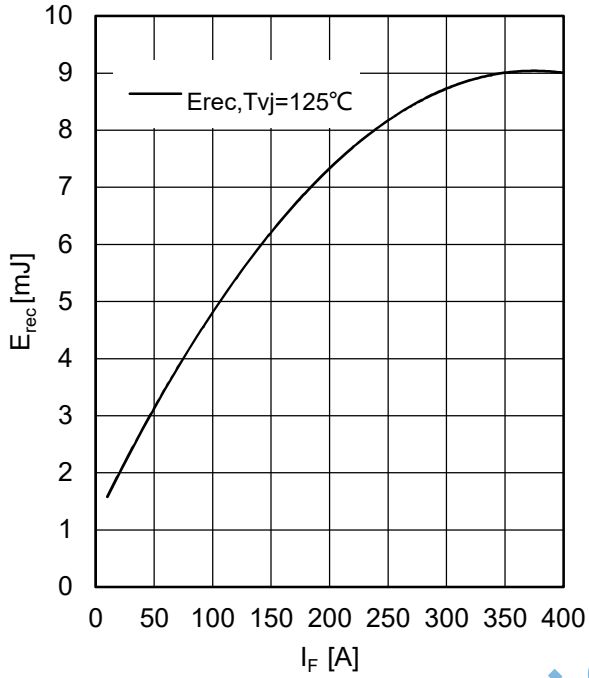
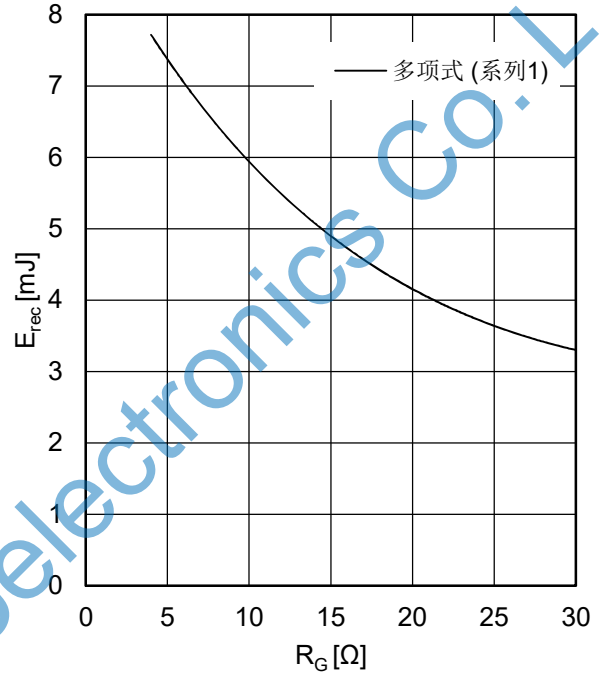

Fig 10. Switching losses Diode

$$E_{rec} = f(R_G)$$

$$I_F = 200A, V_{CE} = 600V$$



Hangzhou Taixin Microelectronics CO., LTD.

Package Dimensions

Dimensions in Millimeters

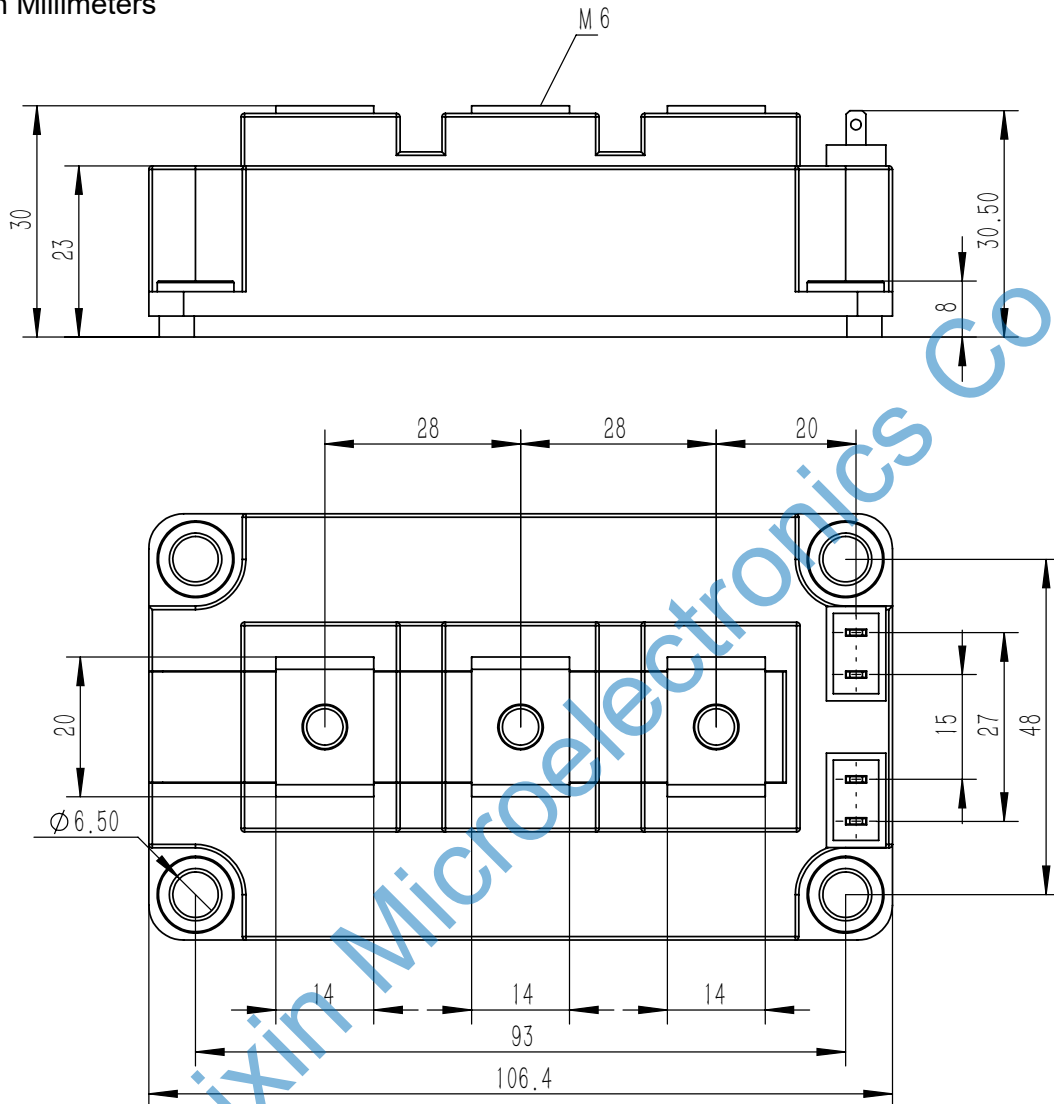

Terms and Conditions of Usage

The data contained in this product datasheet is exclusively intended for technically trained staff who will have to evaluate the suitability of the product for the intended application and the completeness of the product data with respect to such application.

Information in this document is believed to be accurate and reliable. However, TaiXin does not give any representations or warranties, expressed or implied, as to the accuracy or completeness of such information and shall have no liability for the consequences of use of such information.

If you require product information in excess of the data given in this product data sheet or which concerns the specific application of our product, please contact the Salesman, which is responsible for you. For those that are specifically interested we may provide application notes.

Right to make changes TaiXin reserves the right to make changes to information published in this document, including without limitation specifications and product descriptions, at any time and without notice.